

### Fast IGBT & FRED

The Fast IGBT™ is a new generation of high voltage power IGBTs. Using Non-Punch Through Technology the Fast IGBT™ combined with an APT free-wheeling ultraFast Recovery Epitaxial Diode (FRED) offers superior ruggedness and fast switching speed

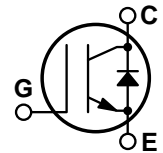
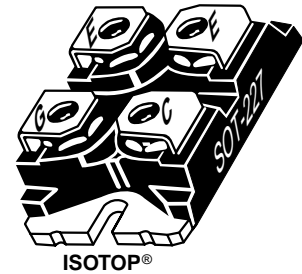

- Low Forward Voltage Drop
- Low Tail Current
- RBSOA and SCSOA Rated
- Ultrafast Soft Recovery Antiparallel Diode
- 20 kHz operation @ 800V, 24A
- 10 kHz operation @ 800V, 40A
- Ultra Low Leakage Current

#### MAXIMUM RATINGS

All Ratings:  $T_C = 25^\circ\text{C}$  unless otherwise specified.

Symbol	Parameter	APT60GF120JRD	UNIT
$V_{CES}$	Collector-Emitter Voltage	1200	Volts
$V_{GE}$	Gate-Emitter Voltage	$\pm 20$	
$V_{GEM}$	Gate-Emitter Voltage Transient	$\pm 30$	
$I_{C1}$	Continuous Collector Current @ $T_C = 25^\circ\text{C}$	115	Amps
$I_{C2}$	Continuous Collector Current @ $T_C = 110^\circ\text{C}$	60	
$I_{CM}$	Pulsed Collector Current <sup>①</sup> @ $T_C = 25^\circ\text{C}$	360	
RBSOA	Reverse Bias Safe Operating Area @ $T_J = 150^\circ\text{C}$	360A @ 960V	
$P_D$	Total Power Dissipation	521	Watts
$T_J, T_{STG}$	Operating and Storage Junction Temperature Range	-55 to 150	$^\circ\text{C}$
$T_L$	Max. Lead Temp. for Soldering: 0.063" from Case for 10 Sec.	300	

#### STATIC ELECTRICAL CHARACTERISTICS

Symbol	Characteristic / Test Conditions	MIN	TYP	MAX	UNIT
$V_{GE(TH)}$	Gate Threshold Voltage ( $V_{CE} = V_{GE}, I_C = 500\mu\text{A}, T_J = 25^\circ\text{C}$ )	3	4.5	6	Volts
$V_{CE(ON)}$	Collector-Emitter On Voltage ( $V_{GE} = 15\text{V}, I_C = 60\text{A}, T_J = 25^\circ\text{C}$ )		2.1	3.4	
	Collector-Emitter On Voltage ( $V_{GE} = 15\text{V}, I_C = 60\text{A}, T_J = 125^\circ\text{C}$ )		2.5	3.4	
$I_{CES}$	Collector Cut-off Current ( $V_{CE} = V_{CES}, V_{GE} = 0\text{V}, T_J = 25^\circ\text{C}$ ) <sup>②</sup>			500	mA
	Collector Cut-off Current ( $V_{CE} = V_{CES}, V_{GE} = 0\text{V}, T_J = 125^\circ\text{C}$ ) <sup>②</sup>			3000	
$I_{GES}$	Gate-Emitter Leakage Current ( $V_{GE} = \pm 20\text{V}, V_{CE} = 0\text{V}$ )			$\pm 100$	nA

 **CAUTION:** These Devices are Sensitive to Electrostatic Discharge. Proper Handling Procedures Should Be Followed.

## DYNAMIC CHARACTERISTICS

APT60GF120JRD

Symbol	Characteristic	Test Conditions	MIN	TYP	MAX	UNIT	
$C_{ies}$	Input Capacitance	<b>Capacitance</b> $V_{GE} = 0V, V_{CE} = 25V$ $f = 1 \text{ MHz}$		7080		pF	
$C_{oes}$	Output Capacitance			815			
$C_{res}$	Reverse Transfer Capacitance			441			
$V_{GEP}$	Gate-to-Emitter Plateau Voltage	<b>Gate Charge</b> $V_{GE} = 15V$ $V_{CE} = 600V$ $I_C = 60A$		9		V	
$Q_g$	Total Gate Charge <sup>③</sup>			695		nC	
$Q_{ge}$	Gate-Emitter Charge			65			
$Q_{gc}$	Gate-Collector ("Miller") Charge			390			
RBSOA	Reverse Bias Safe Operating Area	$T_J = 150^\circ\text{C}, R_G = 5\Omega, V_{GE} = 15V, L = 100\mu\text{H}, V_{CE} = 960V$	360			A	
$t_{d(on)}$	Turn-on Delay Time	<b>Inductive Switching (25°C)</b> $V_{CC} = 800V$ $V_{GE} = 15V$ $I_C = 60A$ $R_G = 5\Omega$ $T_J = +25^\circ\text{C}$		52		ns	
$t_r$	Current Rise Time			79			
$t_{d(off)}$	Turn-off Delay Time			676			
$t_f$	Current Fall Time			56			
$E_{on1}$	Turn-on Switching Energy <sup>④</sup>				TBD		μJ
$E_{on2}$	Turn-on Switching Energy (Diode) <sup>⑤</sup>				8404		
$E_{off}$	Turn-off Switching Energy <sup>⑥</sup>				6806		
$t_{d(on)}$	Turn-on Delay Time		<b>Inductive Switching (125°C)</b> $V_{CC} = 800V$ $V_{GE} = 15V$ $I_C = 60A$ $R_G = 5\Omega$ $T_J = +125^\circ\text{C}$		52		ns
$t_r$	Current Rise Time			65			
$t_{d(off)}$	Turn-off Delay Time			764			
$t_f$	Current Fall Time			126			
$E_{on1}$	Turn-on Switching Energy <sup>④</sup>				TBD		μJ
$E_{on2}$	Turn-on Switching Energy (Diode) <sup>⑤</sup>				11878		
$E_{off}$	Turn-off Switching Energy <sup>⑥</sup>				8955		

## THERMAL AND MECHANICAL CHARACTERISTICS

Symbol	Characteristic	MIN	TYP	MAX	UNIT
$R_{\theta JC}$	Junction to Case (IGBT)			.24	°C/W
$R_{\theta JC}$	Junction to Case (DIODE)			.66	
$W_T$	Package Weight			29.2	gm

- ① Repetitive Rating: Pulse width limited by maximum junction temperature.
- ② For Combi devices,  $I_{ces}$  includes both IGBT and FRED leakages
- ③ See MIL-STD-750 Method 3471.
- ④  $E_{on1}$  is the clamped inductive turn-on-energy of the IGBT only, without the effect of a commutating diode reverse recovery current adding to the IGBT turn-on loss. (See Figure 24.)
- ⑤  $E_{on2}$  is the clamped inductive turn-on energy that includes a commutating diode reverse recovery current in the IGBT turn-on switching loss. A Combi device is used for the clamping diode as shown in the  $E_{on2}$  test circuit. (See Figures 21, 22.)
- ⑥  $E_{off}$  is the clamped inductive turn-off energy. (See Figures 21, 23.)

APT Reserves the right to change, without notice, the specifications and information contained herein.

**TYPICAL PERFORMANCE CURVES**

**APT60GF120JRD**

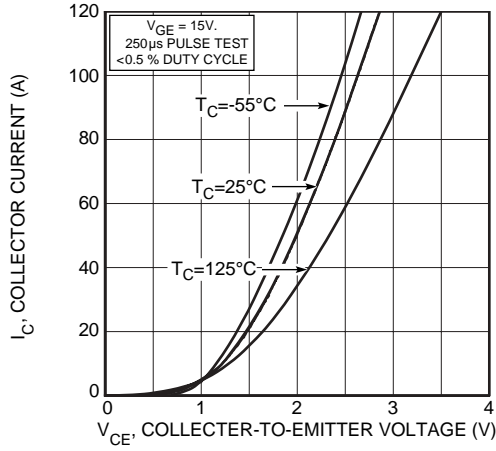

**FIGURE 1, Output Characteristics ( $V_{GE} = 15V$ )**

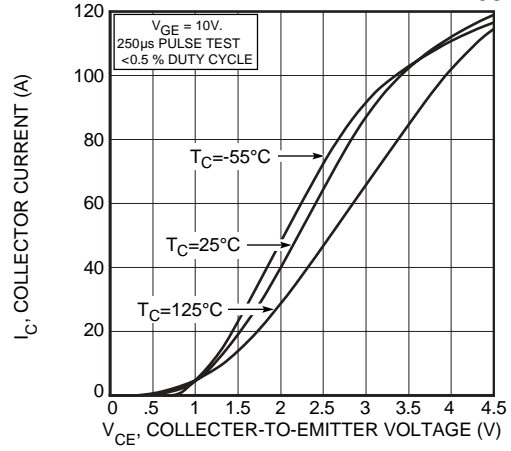

**FIGURE 2, Output Characteristics ( $V_{GE} = 10V$ )**

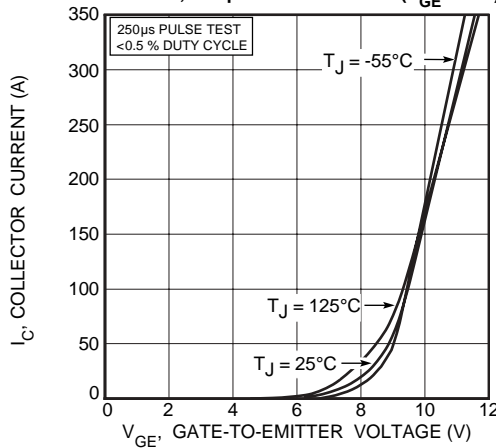

**FIGURE 3, Transfer Characteristics**

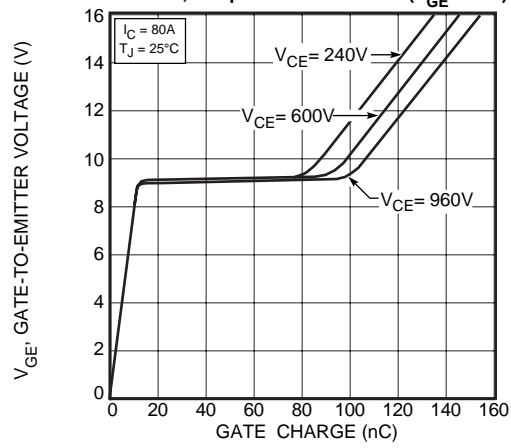

**FIGURE 4, Gate Charge**

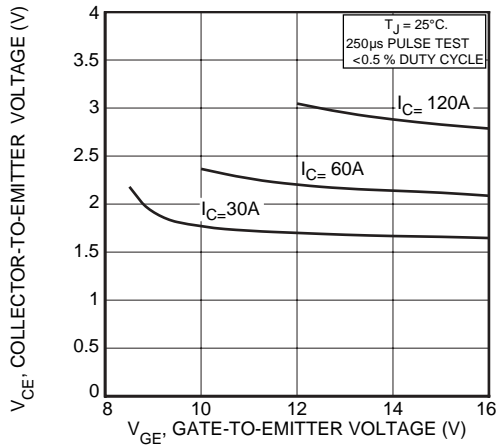

**FIGURE 5, On State Voltage vs Gate-to-Emitter Voltage**

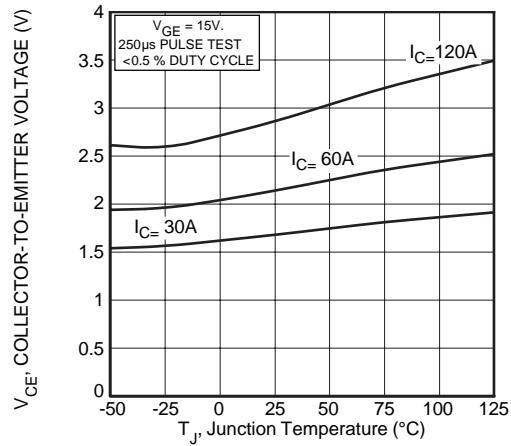

**FIGURE 6, On State Voltage vs Junction Temperature**

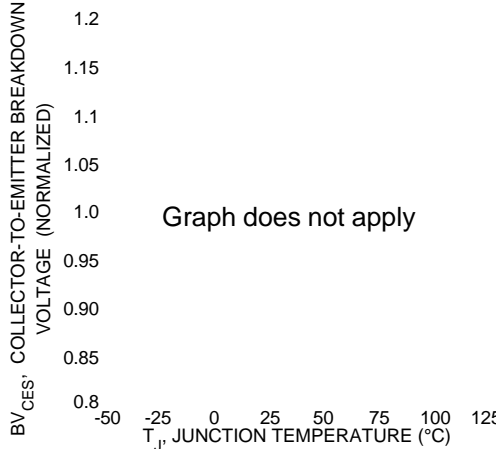

**FIGURE 7, Breakdown Voltage vs. Junction Temperature**

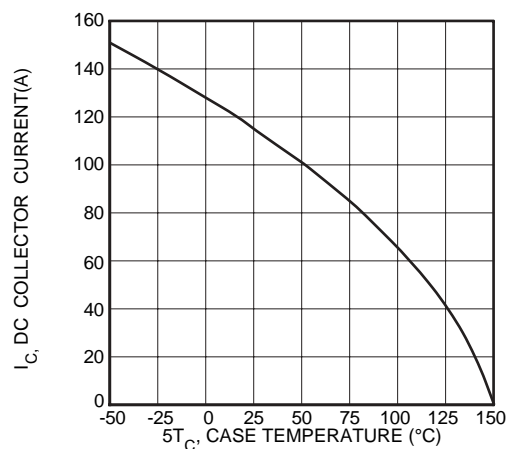

**FIGURE 8, DC Collector Current vs Case Temperature**

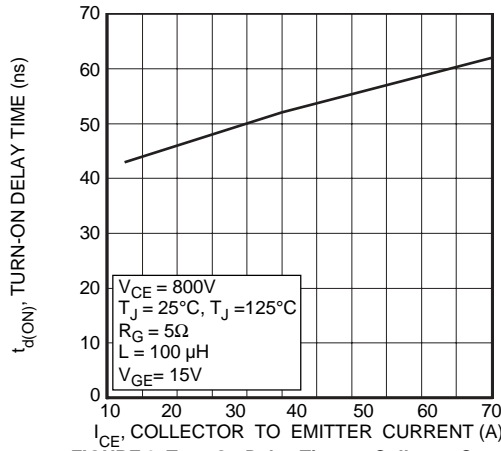

FIGURE 9, Turn-On Delay Time vs Collector Current

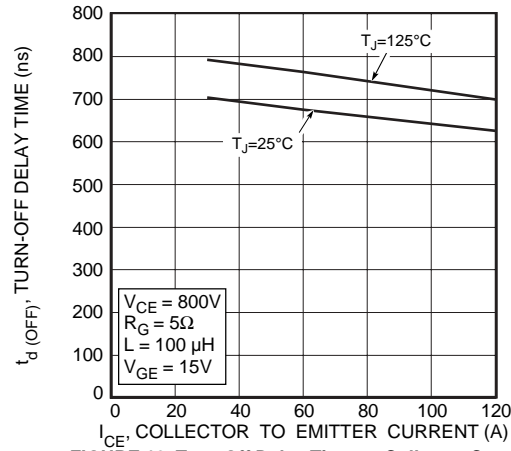

FIGURE 10, Turn-Off Delay Time vs Collector Current

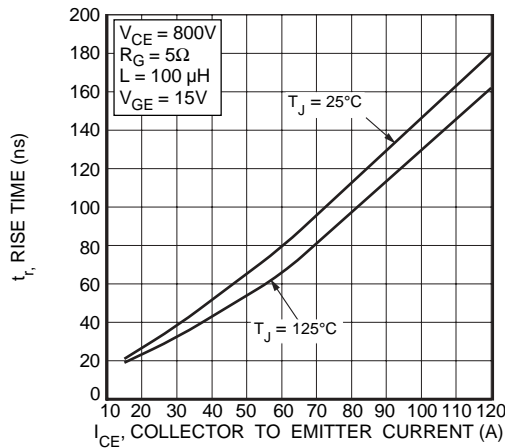

FIGURE 11, Current Rise Time vs Collector Current

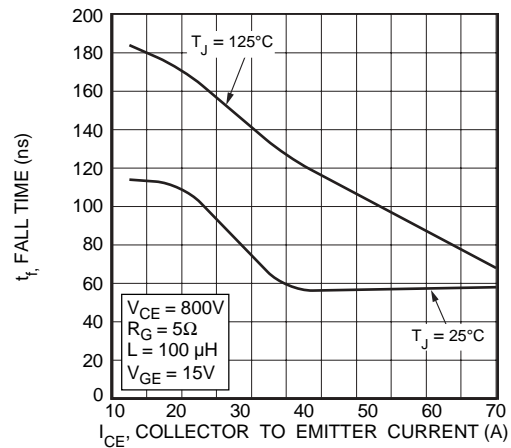

FIGURE 12, Current Fall Time vs Collector Current

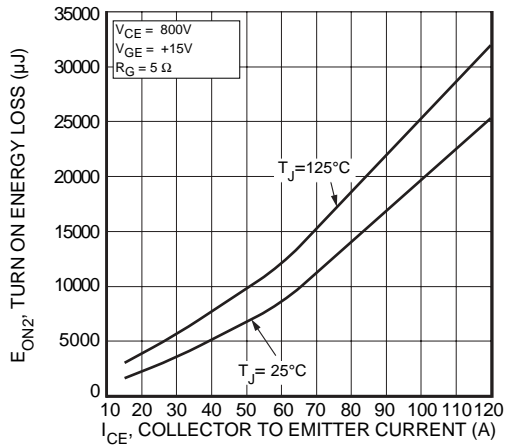

FIGURE 13, Turn-On Energy Loss vs Collector Current

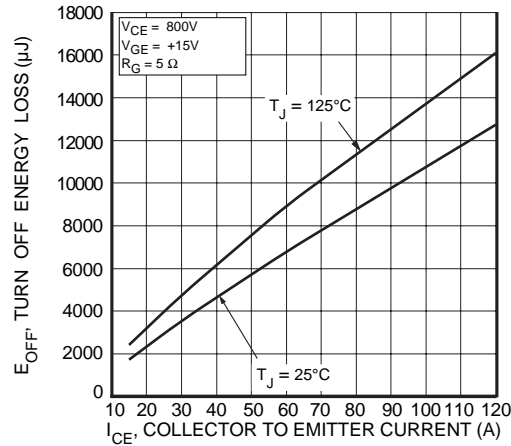

FIGURE 14, Turn Off Energy Loss vs Collector Current

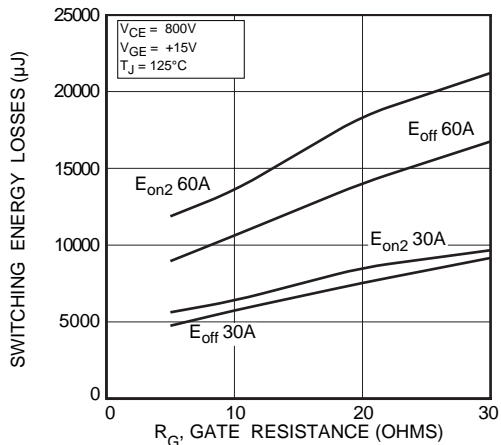

FIGURE 15, Switching Energy Losses vs. Gate Resistance

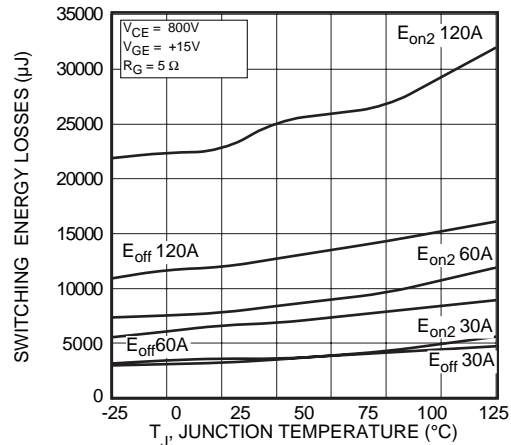

FIGURE 16, Switching Energy Losses vs Junction Temperature

TYPICAL PERFORMANCE CURVES

APT60GF120JRD

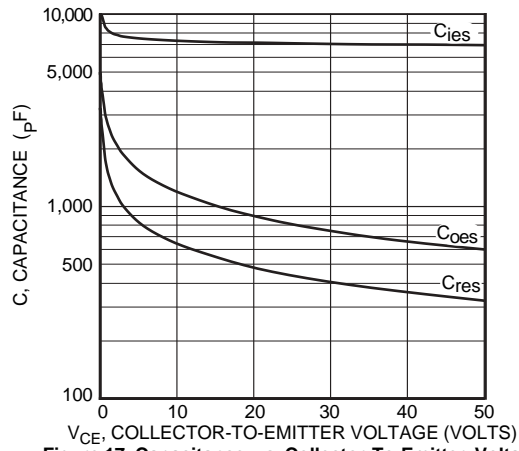

Figure 17, Capacitance vs Collector-To-Emitter Voltage

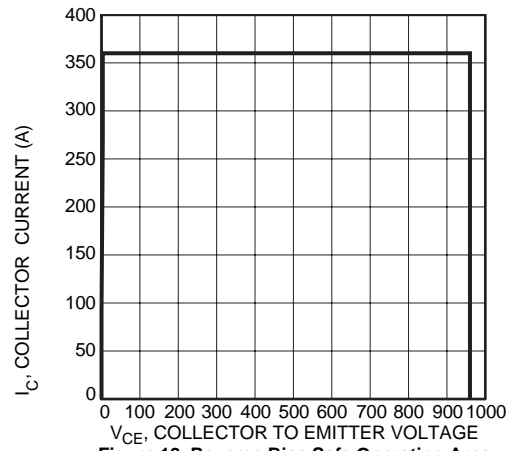

Figure 18, Reverse Bias Safe Operating Area

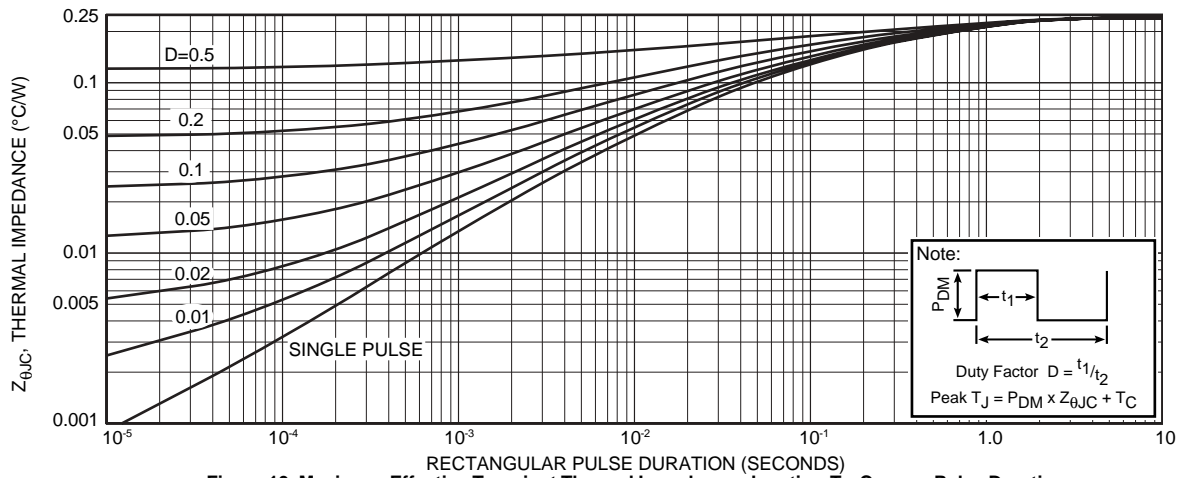

Figure 19, Maximum Effective Transient Thermal Impedance, Junction-To-Case vs Pulse Duration

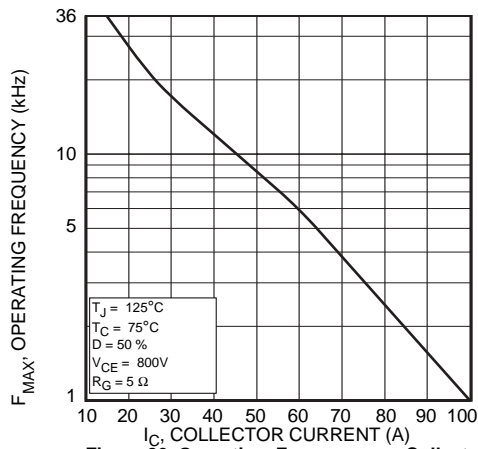

Figure 20, Operating Frequency vs Collector Current

$$F_{max} = \min(f_{max1}, f_{max2})$$

$$f_{max1} = \frac{0.05}{t_{d(on)} + t_r + t_{d(off)} + t_f}$$

$$f_{max2} = \frac{P_{diss} - P_{cond}}{E_{on2} + E_{off}}$$

$$P_{diss} = \frac{T_J - T_C}{R_{\theta JC}}$$

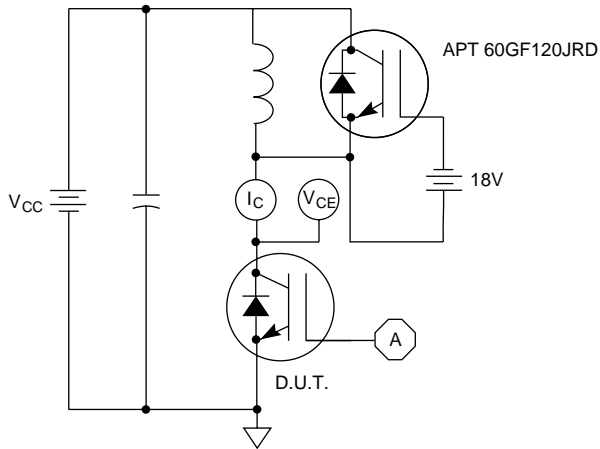

Figure 21. Inductive Switching Test Circuit

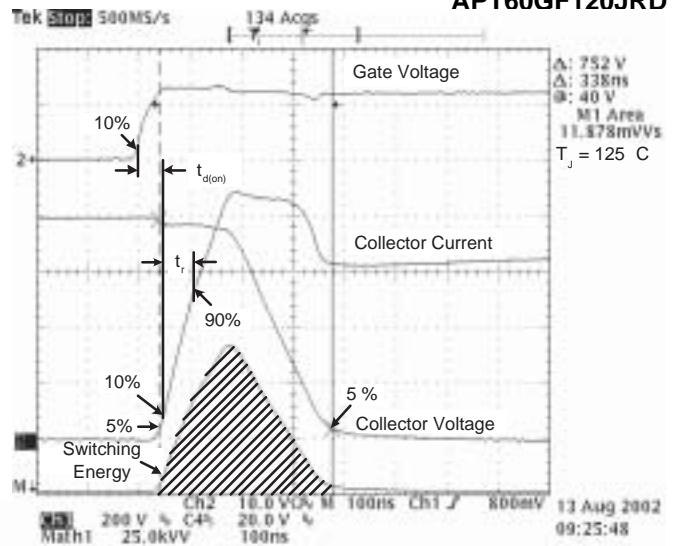

Figure 22. Turn-on Switching Waveforms and Definitions

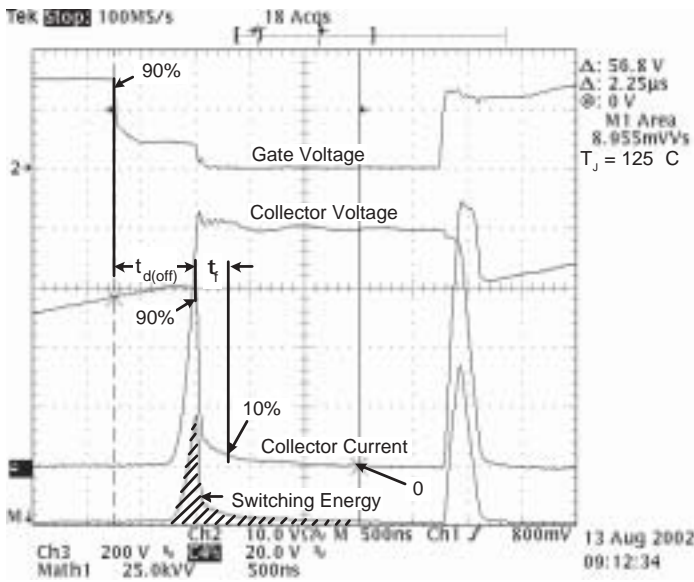

Figure 23. Turn-off Switching Waveforms and Definitions

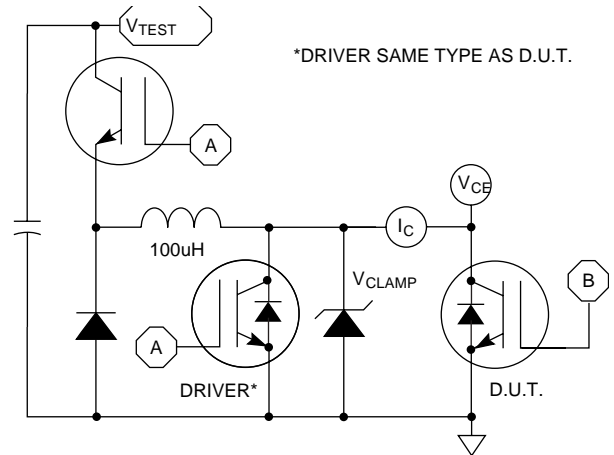

Figure 24.  $E_{ON1}$  Test Circuit

# ULTRAFAST SOFT RECOVERY ANTI-PARALLEL DIODE

## MAXIMUM RATINGS

All Ratings:  $T_C = 25^\circ\text{C}$  unless otherwise specified.

Symbol	Characteristic / Test Conditions	APT60GF120JRD			UNIT
$I_F(\text{AV})$	Maximum Average Forward Current ( $T_C = 80^\circ\text{C}$ , Duty Cycle = 0.5)		60		Amps
$I_F(\text{RMS})$	RMS Forward Current		100		
$I_{\text{FSM}}$	Non-Repetitive Forward Surge Current ( $T_J = 45^\circ\text{C}$ , 8.3ms)		540		

## STATIC ELECTRICAL CHARACTERISTICS

Symbol	Characteristic / Test Conditions	MIN	TYP	MAX	UNIT
$V_F$	Maximum Forward Voltage	$I_F = 60\text{A}$		2.5	Volts
		$I_F = 120\text{A}$		2.0	
		$I_F = 60\text{A}, T_J = 150^\circ\text{C}$		2.0	

## DYNAMIC CHARACTERISTICS

Symbol	Characteristic	MIN	TYP	MAX	UNIT
$t_{\text{rr1}}$	Reverse Recovery Time, $I_F = 1.0\text{A}$ , $di_F/dt = -15\text{A}/\mu\text{s}$ , $V_R = 30\text{V}$ , $T_J = 25^\circ\text{C}$		70	85	ns
$t_{\text{rr2}}$	Reverse Recovery Time		$T_J = 25^\circ\text{C}$	70	
$t_{\text{rr3}}$	$I_F = 60\text{A}$ , $di_F/dt = -480\text{A}/\mu\text{s}$ , $V_R = 650\text{V}$		$T_J = 100^\circ\text{C}$	130	
$t_{\text{fr1}}$	Forward Recovery Time		$T_J = 25^\circ\text{C}$	170	
$t_{\text{fr2}}$	$I_F = 60\text{A}$ , $di_F/dt = 480\text{A}/\mu\text{s}$ , $V_R = 650\text{V}$		$T_J = 100^\circ\text{C}$	170	
$I_{\text{RRM1}}$	Reverse Recovery Current		$T_J = 25^\circ\text{C}$	18	Amps
$I_{\text{RRM2}}$	$I_F = 60\text{A}$ , $di_F/dt = -480\text{A}/\mu\text{s}$ , $V_R = 650\text{V}$		$T_J = 100^\circ\text{C}$	29	
$Q_{\text{rr1}}$	Recovery Charge		$T_J = 25^\circ\text{C}$	630	nC
$Q_{\text{rr2}}$	$I_F = 60\text{A}$ , $di_F/dt = -480\text{A}/\mu\text{s}$ , $V_R = 650\text{V}$		$T_J = 100^\circ\text{C}$	1820	
$V_{\text{fr1}}$	Forward Recovery Voltage		$T_J = 25^\circ\text{C}$	12	Volts
$V_{\text{fr2}}$	$I_F = 60\text{A}$ , $di_F/dt = 480\text{A}/\mu\text{s}$ , $V_R = 650\text{V}$		$T_J = 100^\circ\text{C}$	12	
$di_M/dt$	Rate of Fall of Recovery Current		$T_J = 25^\circ\text{C}$	900	A/ $\mu\text{s}$
	$I_F = 60\text{A}$ , $di_F/dt = -480\text{A}/\mu\text{s}$ , $V_R = 650\text{V}$ (See Figure 33)		$T_J = 100^\circ\text{C}$	600	

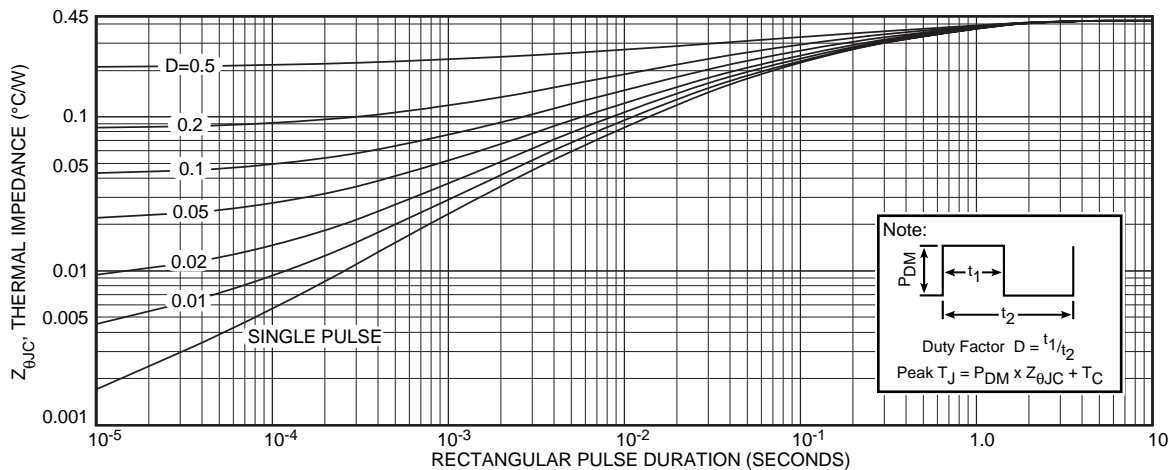

FIGURE 1, MAXIMUM EFFECTIVE TRANSIENT THERMAL IMPEDANCE, JUNCTION-TO-CASE vs PULSE DURATION

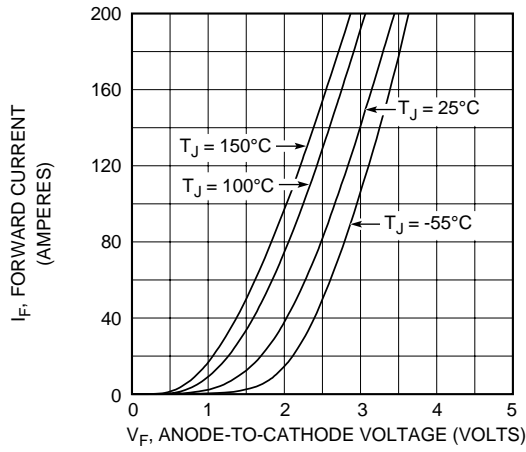

Figure 2, Forward Voltage Drop vs Forward Current

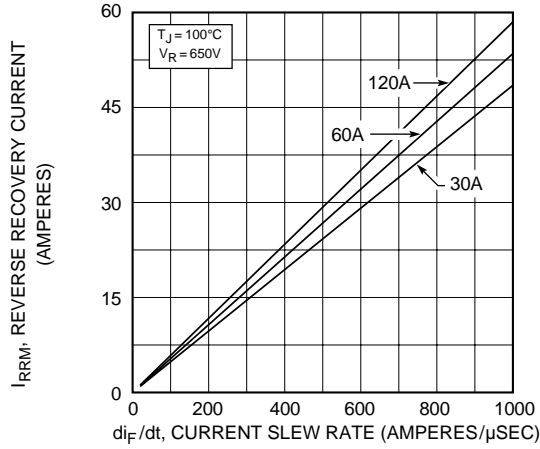

Figure 4, Reverse Recovery Current vs Current Slew Rate

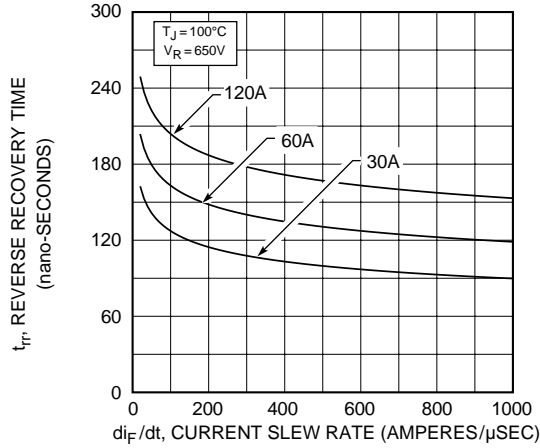

Figure 6, Reverse Recovery Time vs Current Slew Rate

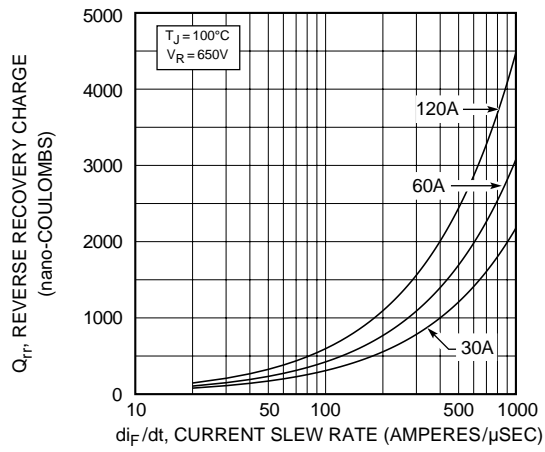

Figure 3, Reverse Recovery Charge vs Current Slew Rate

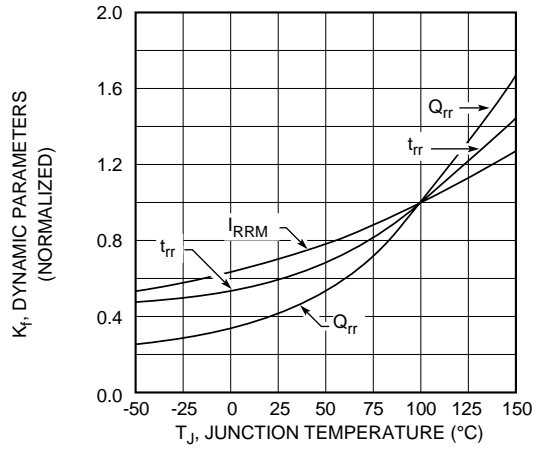

Figure 5, Dynamic Parameters vs Junction Temperature

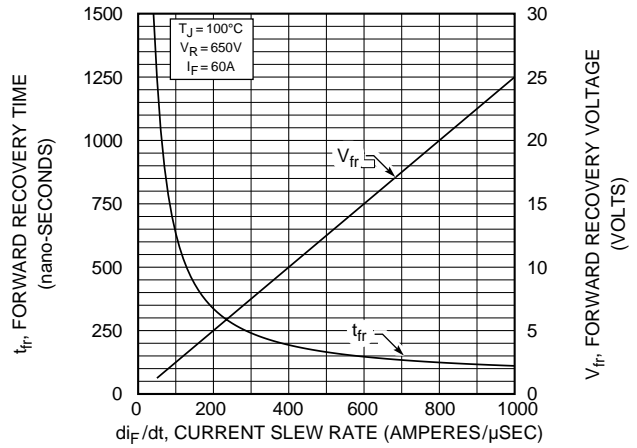

Figure 7, Forward Recovery Voltage/Time vs Current Slew Rate



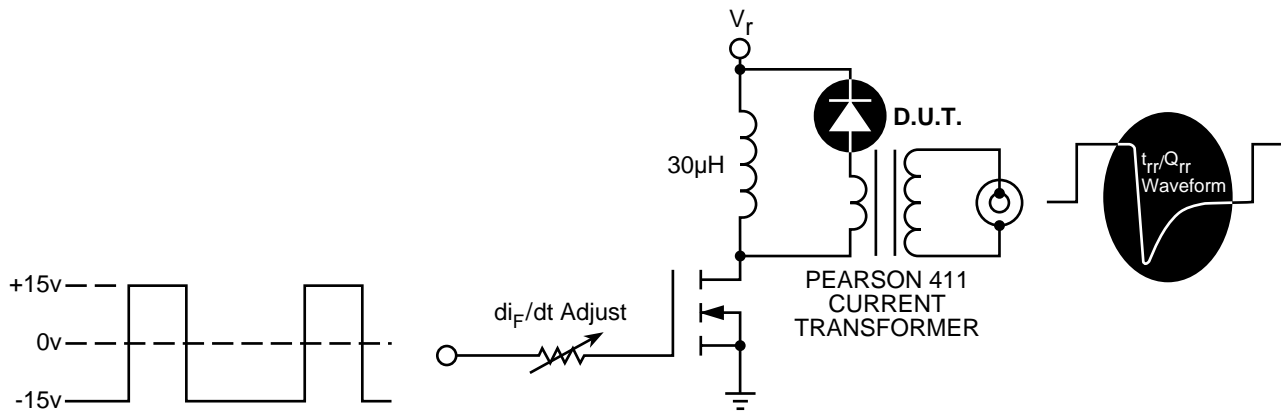

Figure 32, Diode Reverse Recovery Test Circuit and Wave Forms

1  $I_F$  - Forward Conduction Current

2  $di_F/dt$  - Current Slew Rate, Rate of Forward Current Change Through Zero Crossing.

3  $I_{RRM}$  - Peak Reverse Recovery Current.

4  $t_{rr}$  - Reverse Recovery Time Measured from Point of  $I_F$  Current Falling Through Zero to a Tangent Line { 6  $di/dt$  } Extrapolated Through Zero Defined by 0.75 and 0.50  $I_{RRM}$ .

5  $Q_{rr}$  - Area Under the Curve Defined by  $I_{RRM}$  and  $t_{rr}$ .

6  $di/dt$  - Maximum Rate of Current Change During the Trailing Portion of  $t_{rr}$ .

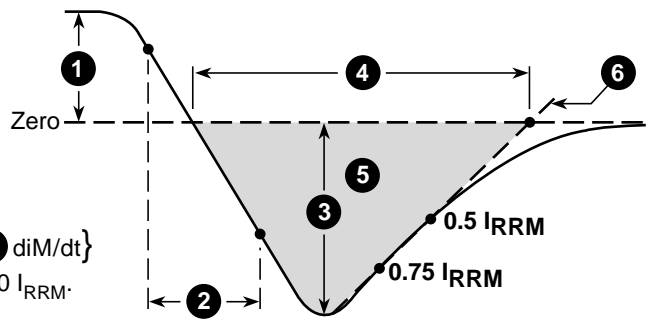

$$Q_{rr} = 1/2 (t_{rr} \cdot I_{RRM})$$

Figure 33, Diode Reverse Recovery Wave Forms and Definitions

### SOT-227 (ISOTOP®) Package Outline

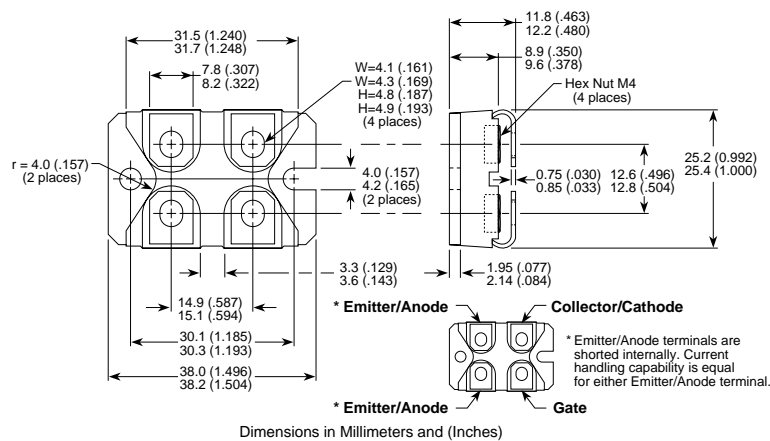

APT's devices are covered by one or more of the following U.S.patents:	4,895,810	5,045,903	5,089,434	5,182,234	5,019,522	5,262,336
	5,256,583	4,748,103	5,283,202	5,231,474	5,434,095	5,528,058